

TECHNICAL SPECIFICATION

MESTRON LIGHTING POLE COMPLY TO BS EN 40-5 : 2002 "LIGHTNING COLUMNS, REQUIREMENT FOR STEEL LIGHTING COLUMNS"

DESIGN OF MESTRON POLE ARE COMPREHENSIVELY ANALYSED USING STAAD. PRO V8i STRUCTURAL DESIGN SOFTWARE TO WITHSTAND 35 M/S WIND-SPEED AT 3 SECOND GUST EQUIVALENT TO 20.6 M/S OF 10 MINUTES MEAN WIND VELOCITY AT 10M HEIGHT WITH TOPOGRAPHY, TERRAIN ROUGHNESS AND STATISTICAL FACTOR OF 1.0

MESTRON POLE DESIGN VALIDATED BY TYPE TEST "DESIGN AND VARIFICATION, VERIFICATION BY TESTING" IN ACCORDANCE TO BS EN 40-3-2 : 2013

MATERIAL USED FOR MESTRON LIGHTING POLE COMPLY TO BS EN 10025 S275 JR : 2004 / JIS G3101 : 2010 SS400 WITH MINIMUM YIELD AND TENSILE STRENGTH OF 275 MPa AND 430 MPa RESPECTIVELY

WELDING PROCESS OF MESTRON LIGHTING POLE IN COMPLIANCE TO WELDING PROCESS SPECIFICATION AS PER BS EN 1011-2 : 2001

MESTRON PRODUCTS ARE PROTECTED WITH ANTI-CORROSIVE TREATMENT WITH HOT-DIP GALVANIZED COATINGS ON FABRICATED IRON AND STEEL ARTICLES IN ACCORDANCE TO ISO 1461 : 2009

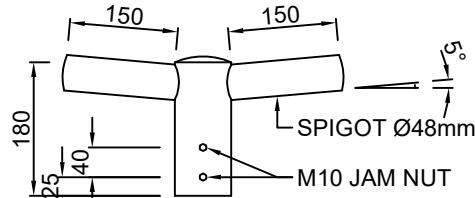
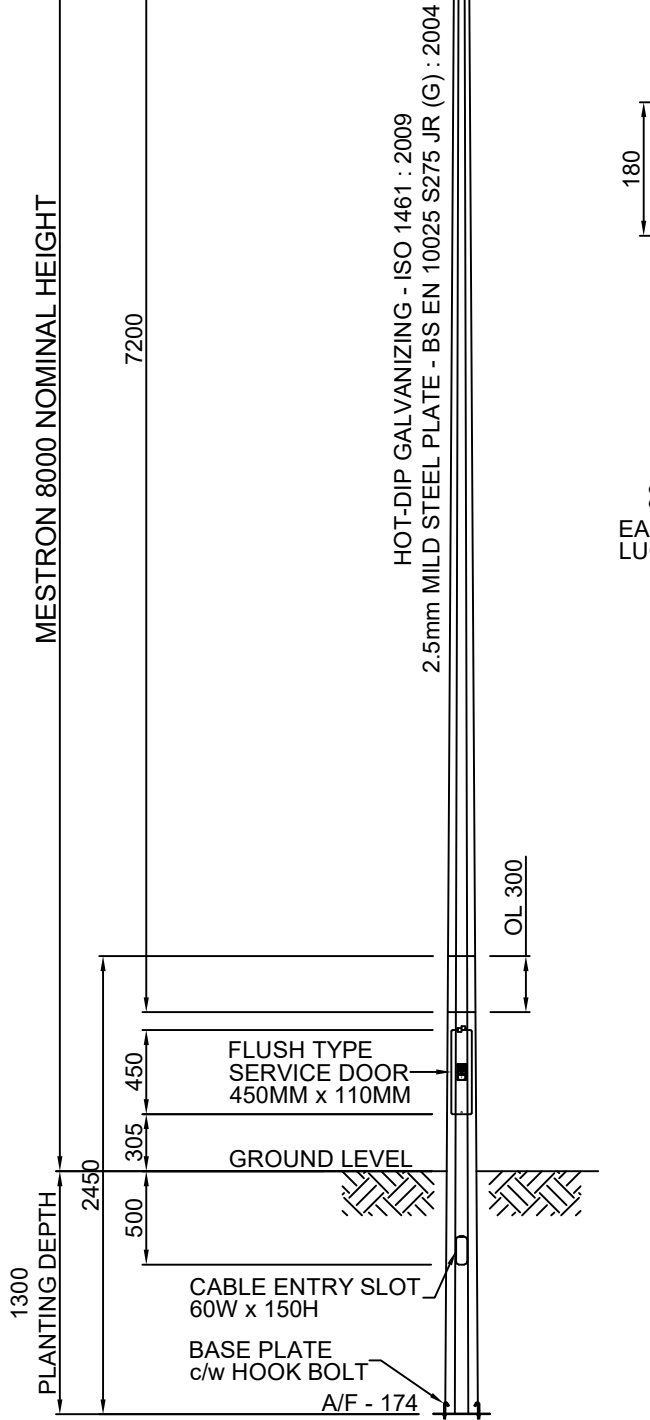

0.15M DOUBLE ARM

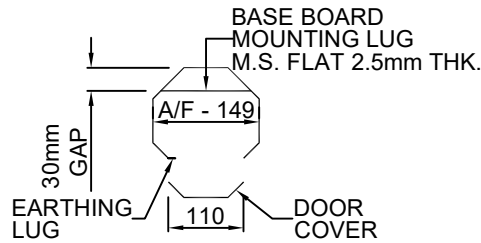

SECTION A-A

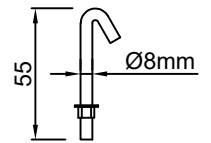

HOOK BOLT

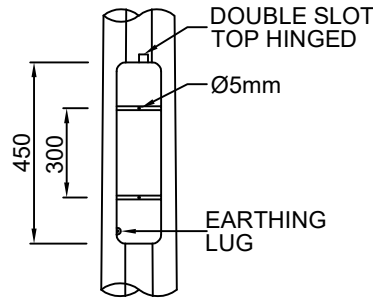

**SERVICE DOOR
DETAIL**

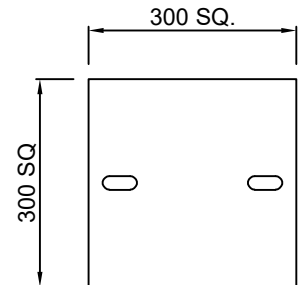

**BASE PLATE
2.5mm THK**

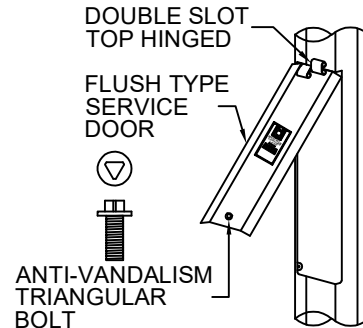

**SERVICE DOOR
DIAGONAL VIEW**

WEIGHT (KGS) : 75 KGS



MESTRON ENGINEERING SDN BHD (591970-X)
 TEL: 603-8069 1815 FAX: 603-8069 1805
 E-MAIL : info@mestron.com.my
 WEB : www.mestron.com.my

DATE	R	DESCRIPTION

DRAWING APPROVAL

SIGN :
 NAME :
 DATE :

8M OCTAGONAL LIGHTING POLE
 PLANTED TYPE
 0.15M DOUBLE ARM

THIS DRAWING IS THE PROPERTY OF
 MESTRON ENGINEERING SDN. BHD.
 AND MUST NOT BE REPRODUCED OR
 MISUSED WITHOUT THEIR PRIOR
 CONSENT IN WRITING.

DRAWN BY : HAFIZ DRAWING NO : 8M-PT-DSA

CHECKED BY : NEO DATE OF ISSUE : 01-06-2019 SCALE : NTS

JO :